

Airborne Electronic Isolated PFC Module

85-264 Vrms Input Voltage	47 - 63Hz / 360 - 800Hz Input Frequency	24 Vdc Output Voltage	100 W Output Power	<1.5% THD	86%@115Vrms / 88%@230Vrms Full Load Efficiency
-------------------------------------	---	---------------------------------	------------------------------	------------------------	--

The AeroQor Isolated PFC Module is a high efficiency, active PFC, AC-DC converter designed to be used as a COTS component in airborne applications. It operates from a universal AC input and generates an isolated DC output. Regulated output and droop output modules are available. Used in conjunction with a hold-up capacitor, and SynQor's AC line filter, the AeroQor will draw a nearly perfect sinusoidal current (PF>0.99) from a single phase AC input. The module is designed with a high level of documentation and traceability.



Designed and manufactured in the USA

Operational Features

- Isolated 100W output power
- Universal input frequency range: 47 - 63Hz / 360 - 800Hz
- Input voltage range: 85-264Vrms
- <1.5% THD at 115Vrms, full load
- Internal inrush current limit
- Auxiliary 10V bias supply, primary-side referenced
- Can be paralleled (droop version only)

Control Features

- PFC Enable
- AC Power Good Signal
- DC Power Good Signal

Protection Features

- Input current limit and auto-recovery short circuit protection
- Auto-recovery input under/over-voltage protection
- Auto-recovery output over-voltage protection
- Auto-recovery thermal shutdown

Mechanical Features

- Industry standard Half-brick size
- Size: 2.386" x 2.486" x 0.512" (60.6 x 63.1 x 13.0 mm)
- Weight: 4.8 oz (136 g)

Specification Compliance

When used with SynQor ACF-U-230-QM filter

- RTCA/DO-160G
- Airbus ABD0100.1.8
- Boeing 787B3-0147
- Boeing D6-36440
- Boeing D6-44588

Safety Features

- Input to Output reinforced isolation 4250Vdc
- Input/Output to baseplate isolation 2150Vdc
- CE Marked

Contents

	Page No.
Typical Connection Diagram	2
Technical Specification	3
Standards & Qualification	9
Application Section	10
Encased Mechanical	15
Ordering Information	17

Typical Connection Diagram

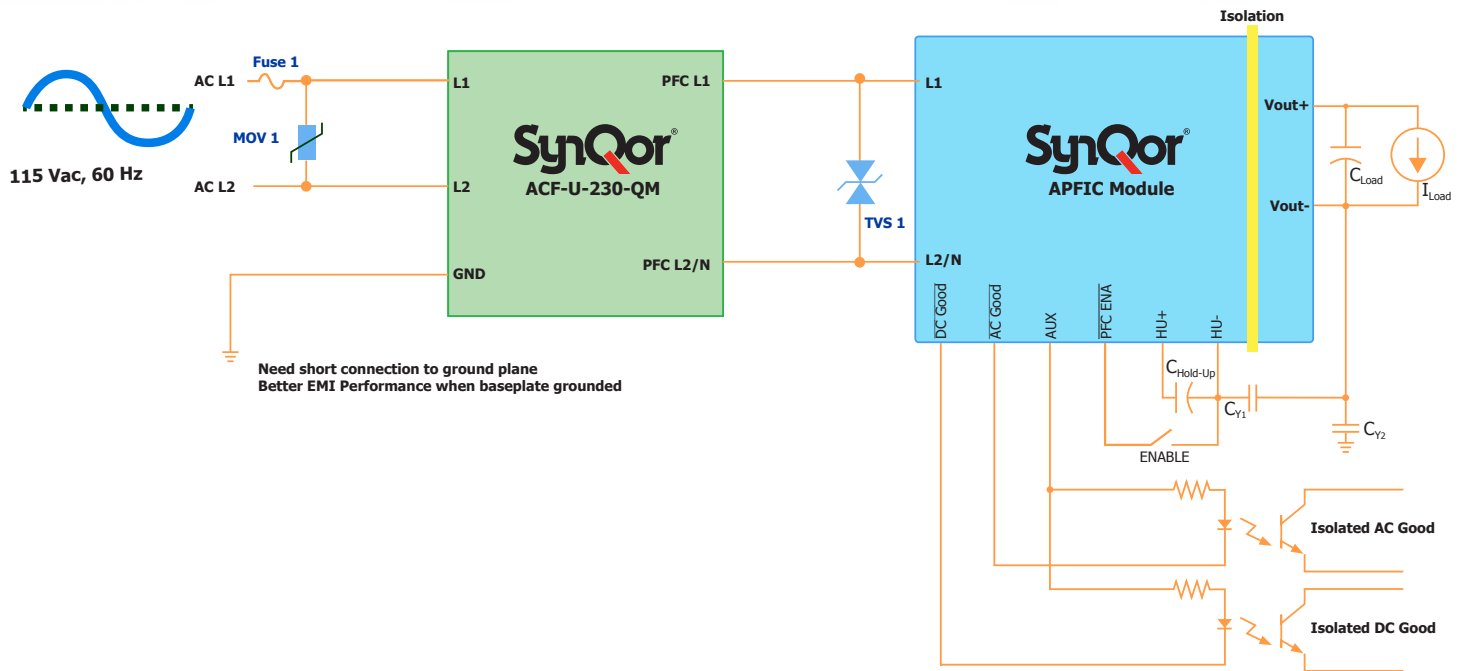

- Fuse 1: 5A / 250V Fuse
 MOV₁, TVS₁: Must prevent peak voltage from exceeding 575V during all transients.
 Must also not be acting for the desired operating range.
 C_{Hold-Up}: 50 - 500 μ F (Dependent on Power Level and Line Frequency)
 C_{Y1-Y2}: See "EMI Considerations" in application notes

Example Parts:

- Fuse 1: 250VAC, 5A; Littelfuse 0216005.MXEP
 MOV₁: 300VAC, 60J; EPCOS S10K300E2
 TVS₁: 400V, 3J; two VISHAY 1.5KE200CA devices connected in series
 CHold-Up: One 450V, 330 μ F; EPCOS B43508B5337M
 CY1: 10nF equivalence (Two paralleled banks of 2x 10nF capacitors in series), Knowles Syfer 2220YA250103KXTB16
 CY2: 10nF, 250VAC; Knowles Syfer 2220YA250103KXTB16

Figure A: Typical Application of the APFIC module to create a multiple-output AC-DC Power Supply



APFIC-U-24x-HM-x
Input: 85-264 Vrms
Output: 24 Vdc
Power: 100 W

Technical Specification

APFIC-U-24x-HM-x Electrical Characteristics

Operating conditions of 115Vrms, 60Hz input, 4.2A output, 200µF bulk capacitance, and baseplate temperature = 25°C unless otherwise noted; full operating baseplate temperature range is -40 °C to +100 °C with appropriate power derating. Specifications subject to change without notice.

Parameter	Min.	Typ.	Max.	Units	Notes & Conditions
ABSOLUTE MAXIMUM RATINGS					
Input Voltage (L1 to L2/N)			575	Vpk	
Isolation Voltage (Input to Output)			4250	Vdc	See Note 3
Isolation Voltage (Input/Output to Baseplate)			2150	Vdc	See Note 3
Operating Temperature	-40		100	°C	Baseplate temperature
Storage Temperature	-55		125	°C	
Voltage at AC GOOD and pins	-0.3		16	V	Referenced to HU-
Voltage at DC GOOD and pins	-0.3		16	V	Referenced to HU-
Current drawn from AUX pin	0		10	mADC	
Voltage at PFC enable pin	-2		575	V	Referenced to HU-
INPUT CHARACTERISTICS					
Operating Input Voltage Range					
AC Input Continuous	85		264	Vrms	
AC Input 100ms Transient	40		290	Vrms	
Input Under-Voltage Lockout		30		Vrms	>1s duration
Input Over-Voltage Shutdown		440		Vpk	
Operating Input Frequency					
50/60Hz Range, for Startup	47		63	Hz	
400Hz Range, for Startup	360		800	Hz	
Operational	45		800	Hz	After startup, unit operates over wide frequencies
Power Factor of AC Input Current					
50/60Hz		0.99			100W output (with SynQor QM AC filter)
400Hz		0.98			100W output (with SynQor QM AC filter)
Reactive Power		3.3		VAR	115 Vrms 400Hz; leading, see Note 5
Total Harmonic Distortion of AC Input Current		1.5		%	60/400Hz 115 Vrms single-phase, see Note 1
Individual Current Harmonic Distortion Levels at 115 Vrms					Below RTCA/DO-160G/787B3/ABD0100.1.8
Inrush of AC Input Current					Meets RTCA/DO-160G section 16.7.5
t < 3ms			1	Apk	Meets 9 x steady state load limit, see Note 7
3ms < t < 500ms			3	Apk	Meets 4 x steady state load limit, see Note 7
t > 500ms			3	Apk	Meets 2 x steady state load limit, see Note 7
Enabled AC Input Current (no load)		100	180	mArms	115 Vrms input
Disabled AC Input Current		30	50	mArms	
Maximum Input Power			130	W	
Maximum Input Current			1.5	Arms	85 Vrms input
OUTPUT CHARACTERISTICS					
Output Voltage Set Point at Full Load					See Figure 8 for V-I curve
Regulated Option	23.7	24.0	24.3	Vdc	Vin<250Vrms, for higher Vin see application notes
Droop Option	23.5	24.1	24.7	Vdc	
Droop Option, Current Share Analysis	24.0	24.1	24.2	Vdc	Tolerance for droop share operation, see Note 6
Total Output Voltage Range					See Figure 8 for V-I curve
Regulated Option	23.4		25.0	Vdc	Vin<250Vrms, for higher Vin see application notes
Droop Option	23.4		25.5	Vdc	
Output Voltage Ripple and Noise at 60 Hz					See Note 2
Peak-to-Peak			1.0	%	With 200µF hold-up capacitance, full load at 60Hz
RMS			0.4	%	
Output Voltage Ripple and Noise at 400Hz					With 200µF hold-up capacitance, full load at 400Hz
Peak-to-Peak			0.15	%	
RMS			0.06	%	
Operating Output Current Range	0		4.2	A	
Output Current Limit					Unit continues to operate for 1s before shutdown
115 Vrms		7.3		A	
230 Vrms		7.8		A	
Maximum Output Capacitance			2,000	µF	At half resistive load
HOLD-UP CHARACTERISTICS					
Typical Hold-up Voltage		400		Vdc	
Hold-up Voltage Range	385		415	Vdc	Hold-up voltage varies with load
Hold-up Over-Voltage Protection Threshold	440		460	Vdc	
Hold-up Under-Voltage Shutdown Threshold		200		Vdc	
Hold-up Capacitance	50		500	µF	See Note 3
External Common-Mode Capacitance			20	nF	

Technical Specification

APFIC-U-24x-HM-x Electrical Characteristics

Operating conditions of 115Vrms, 60Hz input, 4.2A output, 200µF bulk capacitance, and baseplate temperature = 25°C unless otherwise noted; full operating baseplate temperature range is -40 °C to +100 °C with appropriate power derating. Specifications subject to change without notice.

Parameter	Min.	Typ.	Max.	Units	Notes & Conditions
Efficiency					
100% Load at 115Vrms		86		%	See Figure 1 and 2 for efficiency curve
100% Load at 230Vrms		88		%	See Figure 1 and 2 for efficiency curve
DYNAMIC CHARACTERISTICS					
Turn-On Transient					
Start-up Inhibit Time		10		ms	
Turn-On Time		2		s	
Output Voltage Overshoot		0	2	%	
ISOLATION CHARACTERISTICS (Input to output)					
Isolation Test Voltage (Dielectric Strength)		4250		Vdc	See absolute maximum ratings, Note 4
Isolation Resistance	100			MΩ	
Isolation Capacitance		100		pF	
ISOLATION CHARACTERISTICS (Input/output to baseplate)					
Isolation Test Voltage (Dielectric Strength)		2150		Vdc	See absolute maximum ratings, Note 4
Isolation Resistance	100			MΩ	
TEMPERATURE LIMITS FOR POWER DERATING CURVES					
Semiconductor Junction Temperature			125	°C	
Board Temperature			125	°C	
Transformer Temperature			125	°C	
Maximum Baseplate Temperature, T _B			100	°C	
FEATURE CHARACTERISTICS					
Hold-up Capacitor Precharge					
Precharge Current		50		mA	
Hold-up Short-Circuit Withstand			indefinite	s	
Free Running Switching Frequency		125		kHz	
PFC Enable (PFC ENA)					
Off-State Voltage	2			V	Referenced to HU-
On-State Voltage			0.8	V	
Internal Pull-Up Voltage		5		V	
Internal Pull-Up Resistance		10		kΩ	
AC Good (AC GOOD)					
AC Input Voltage for AC Good	119		375	Vpk	Referenced to HU-
Pull-down resistance			20	Ω	Open collector
DC Good (DC GOOD)					
Pull-down resistance			20	Ω	Open collector
Over-Temperature Protection					
Disable Threshold			125	°C	Measured at surface of internal PCB
High Enable Threshold		120		°C	
Auxiliary Bias Supply					
Voltage Range (≤3 mA Load)	7		12	V	Referenced to HU-
Maximum Source Current			10	mA DC	
Equivalent Series Resistance		1		kΩ	
RELIABILITY CHARACTERISTICS					
Calculated MTBF per Telcordia SR-332, Issue 2		981		kHrs	Ground Benign, T _B = 70°C
Calculated MTBF per MIL-HDBK-217F		840		kHrs	Ground Benign, T _B = 70°C
Calculated MTBF per MIL-HDBK-217F		108		kHrs	Airborne Inhabited Cargo, T _B = 70°C

Note 1: Individual current harmonic distortion Levels below RTCA/DO-160G, Airbus ABD0100.1.8, Boeing 787B3 Requirements

Note 2: 200µF electrolytic hold-up capacitor having a typical ESR of 0.5Ω. Ripple amplitude dependent on capacitance and ESR of hold-up capacitor.

Note 3: The converter is able to operate with a minimum of 50µF of hold-up capacitance, but SynQor recommends at least 330µF if the power system will be required to conform to lightning surge standards. The converter relies on the hold-up capacitor to absorb the energy from a lightning surge.

Note 4: 1 minute for qualification test, and less than 1 minute in production.

Note 5: External input filter will contribute to this parameter.

Note 6: For use with droop share analysis. Assumes uniform thermal environment for modules in parallel.

Note 7: Tested according to section 16.7.5 of RTCA/DO-160G. APFIC startup (t = 0) conducted at the AC voltage zero crossing (115 Vrms, 400Hz), 200µF hold-up

SynQor[®]

Technical Specification

APFIC-U-24x-HM-x
Input: 85-264 Vrms
Output: 24 Vdc
Power: 100 W

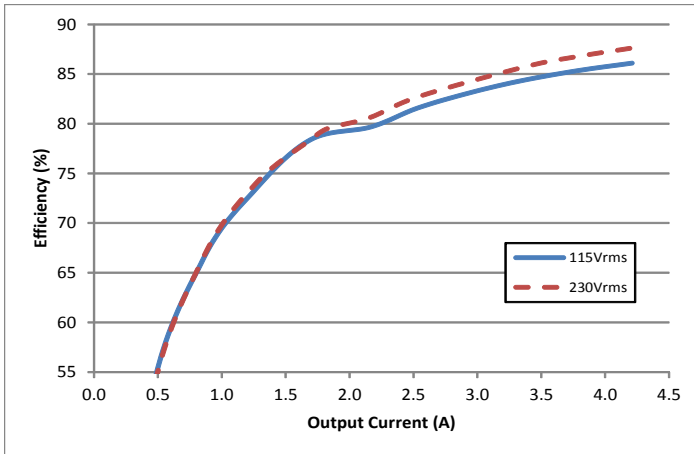

Figure 1: Efficiency at nominal output voltage vs. output current for 115Vrms and 230Vrms (60Hz) input voltage at $T_b = 25^\circ\text{C}$.

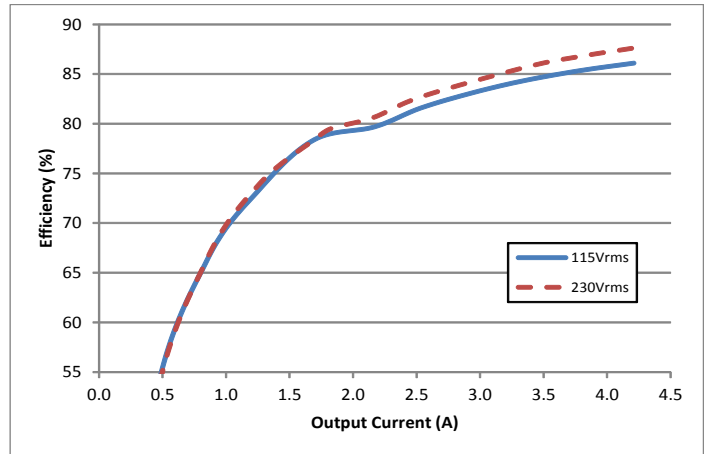

Figure 2: Efficiency at nominal output voltage vs. output current for 115Vrms and 230Vrms (400Hz) input voltage at $T_b = 25^\circ\text{C}$.

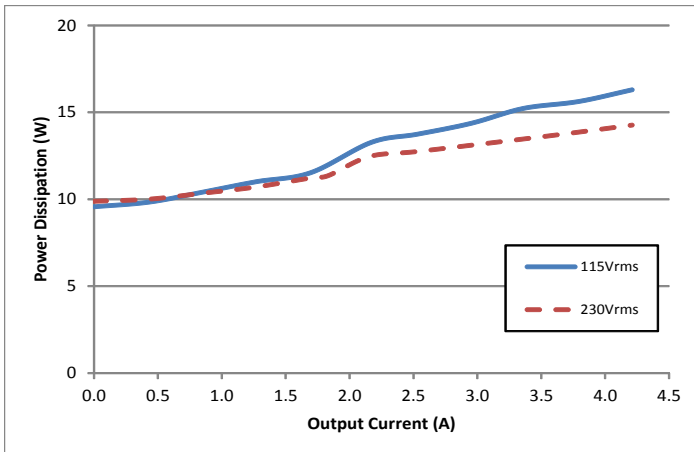

Figure 3: Power dissipation at nominal output voltage vs. output current for 115Vrms and 230Vrms (60Hz) input voltage at $T_b = 25^\circ\text{C}$.

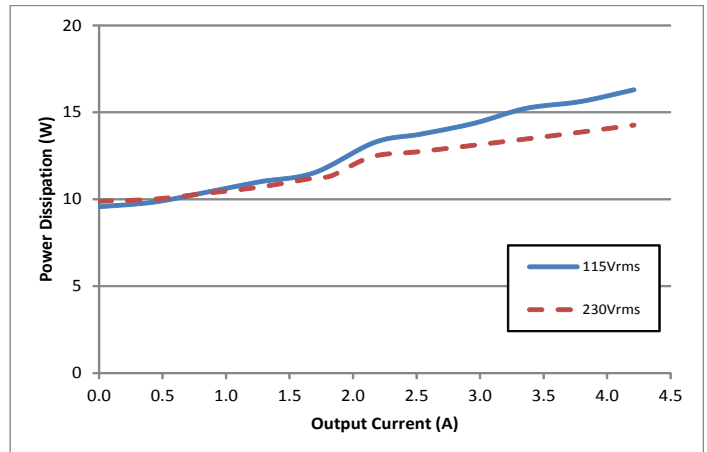

Figure 4: Power dissipation at nominal output voltage vs. output current for 115Vrms and 230Vrms (400Hz) input voltage at $T_b = 25^\circ\text{C}$.

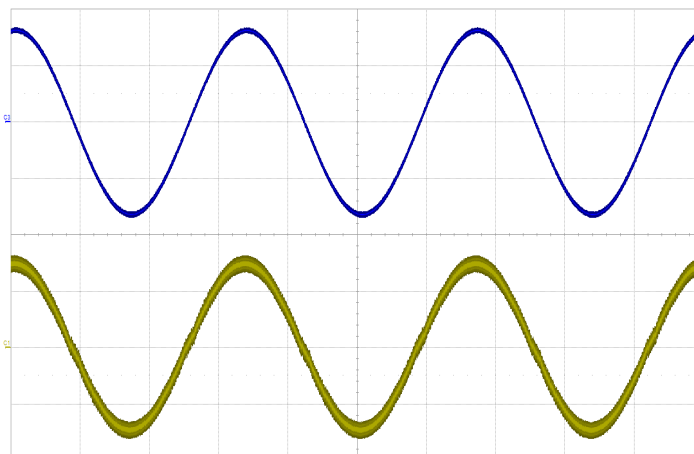

Figure 5: Typical Input Voltage and Current waveforms at full load current (115Vrms, 60Hz) Top: V_{in} (100V/div), Bottom: I_{in} (1A/div), Timebase: (5ms/div).

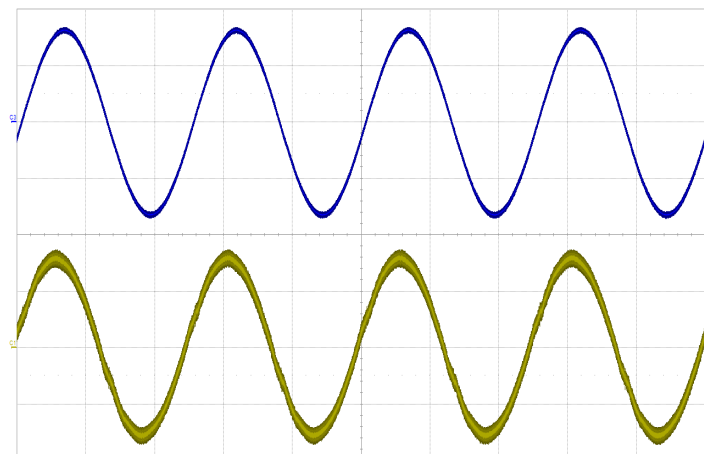

Figure 6: Typical Input Voltage and Current waveforms at full load current (115Vrms, 400Hz) Top: V_{in} (100V/div), Bottom: I_{in} (1A/div), Timebase: (1ms/div).

SynQor®

Technical Specification

APFIC-U-24x-HM-x
Input: 85-264 Vrms
Output: 24 Vdc
Power: 100 W

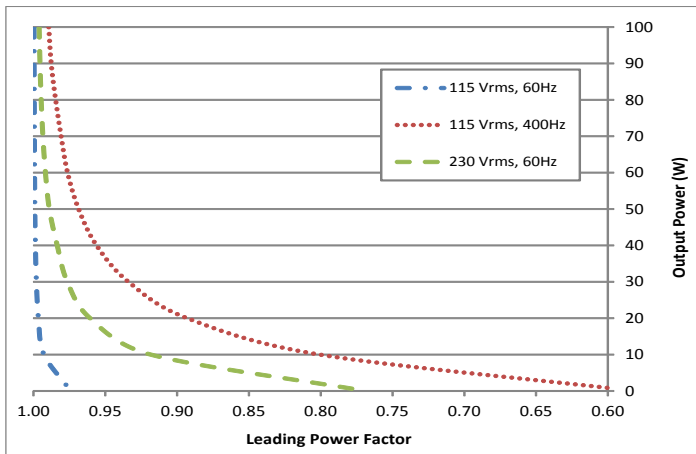

Figure 7: Output power vs. leading power factor (Tested with APFIC module and ACF-U-230-QM).

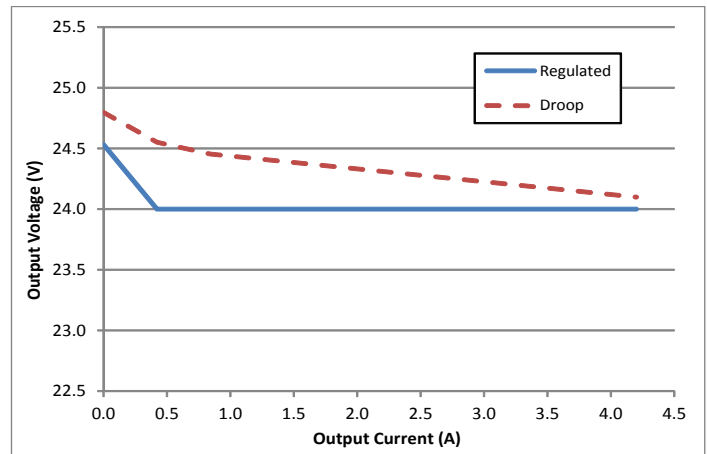

Figure 8: Typical output voltage vs. output current for regulated and droop version outputs.

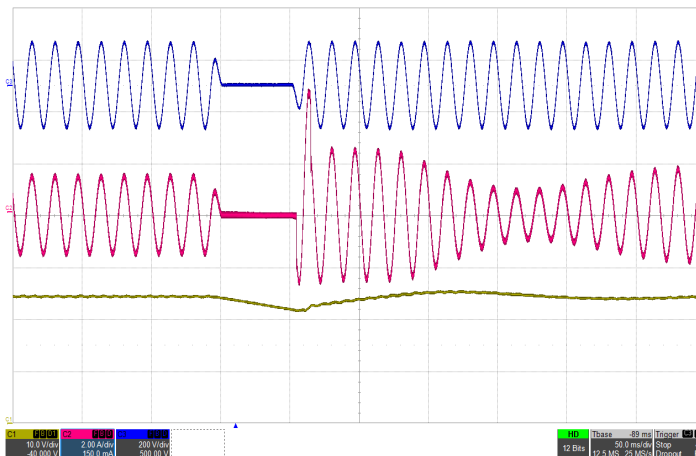

Figure 9: Line drop out with 400µF hold-up capacitor at full load current (115Vrms, 60Hz) Top: Vin (200V/div), Mid: Iin (2A/div), Bottom: Vout (10V/div), Timebase: (50ms/div).

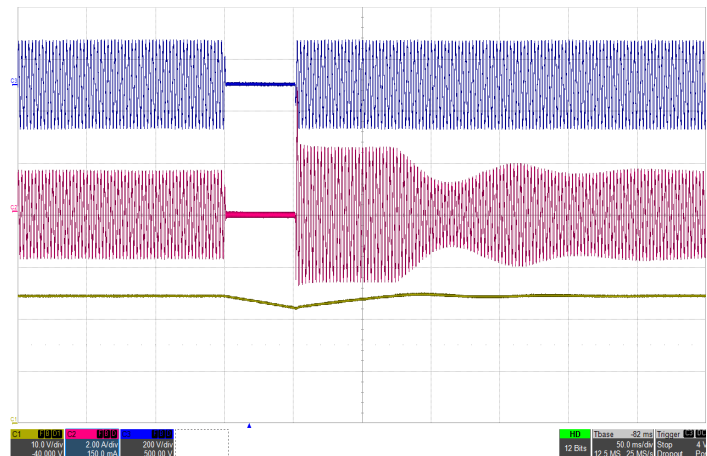

Figure 10: Line drop out with 400µF hold-up capacitor at full load current (115Vrms, 400Hz) Top: Vin (200V/div), Mid: Iin (2A/div), Bottom: Vout (10V/div), Timebase: (50ms/div).

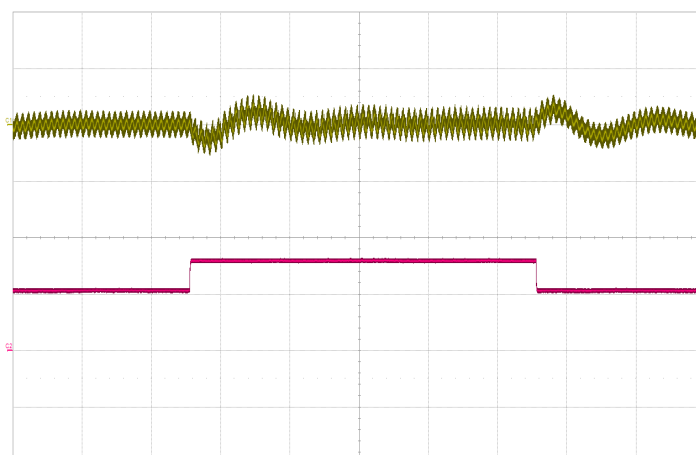

Figure 11: Regulated model output voltage response to step-change in load current with 200µF hold-up capacitor (50%-75%-50% of Iout(max), 115Vrms, 60Hz) Top: Vout (1V/div), Bottom: Iout (2A/div), Timebase: (100ms/div).

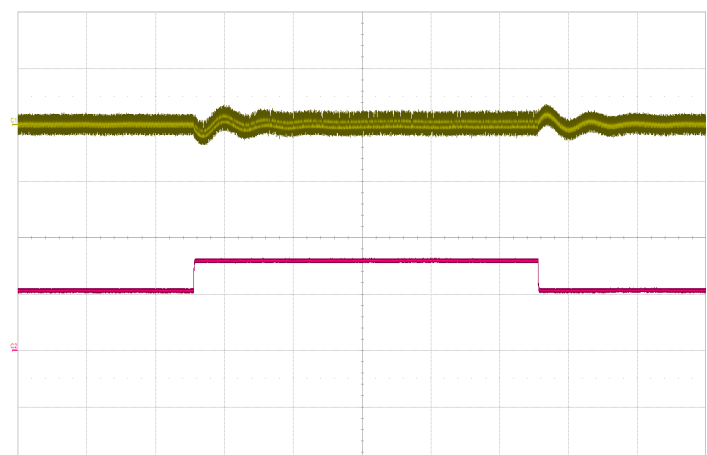

Figure 12: Regulated model output voltage response to step-change in load current with 200µF hold-up capacitor (50%-75%-50% of Iout(max), 115Vrms, 400Hz) Top: Vout (1V/div), Bottom: Iout (2A/div), Timebase: (100ms/div).

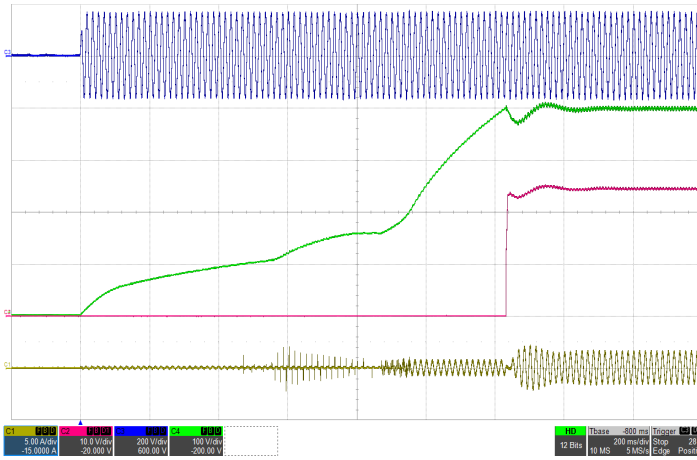

Figure 13: Typical startup waveform with 200µF hold-up capacitor (115Vrms, 60Hz) Top: Vin (200V/div), Top Middle: Hold-up capacitor voltage (100V/div), Bottom Middle: Vout (10V/div), Bottom: Iin (5A/div), Timebase: (200ms/div).

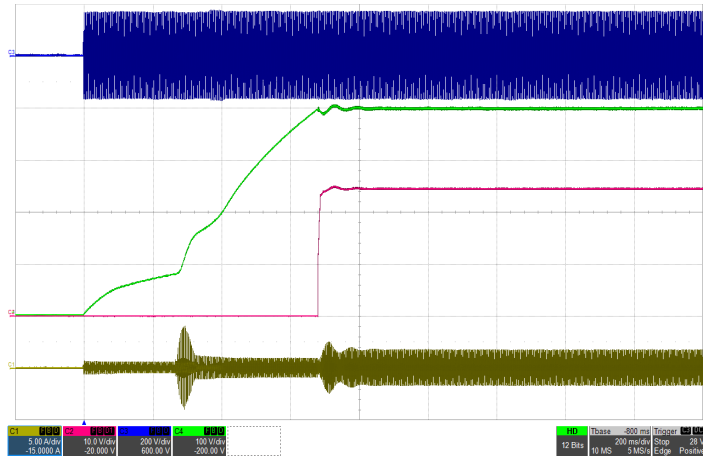

Figure 14: Typical startup waveform with 200µF hold-up capacitor (115Vrms, 400Hz) Top: Vin (200V/div), Top Middle: Hold-up capacitor voltage (100V/div), Bottom Middle: Vout (10V/div), Bottom: Iin (5A/div), Timebase: (200ms/div).

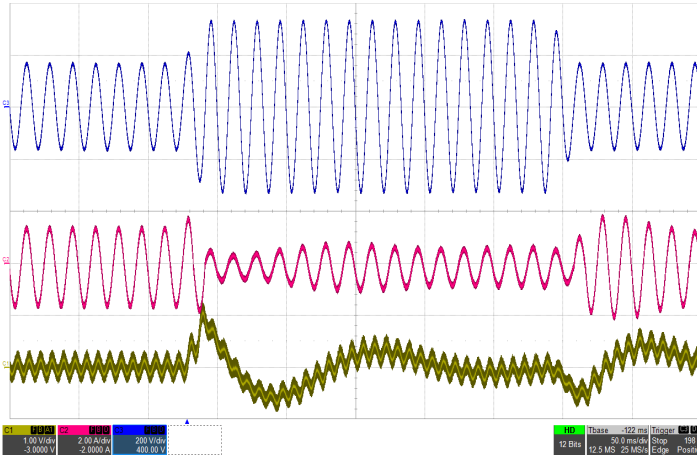

Figure 15: Input voltage transient response with 200µF hold-up capacitor at full load current (115Vrms-230Vrms-115Vrms, 60Hz), Top: Vin (200V/div), Mid: Iin (2A/div), Bottom: Vout (1V/div), Timebase: (50ms/div).

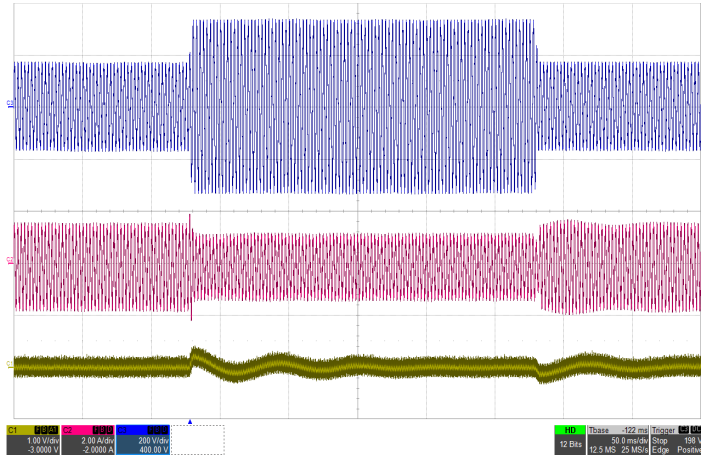

Figure 16: Input voltage transient response with 200µF hold-up capacitor at full load current (115Vrms-230Vrms-115Vrms, 400Hz), Top: Vin (200V/div), Mid: Iin (2A/div), Bottom: Vout (1V/div), Timebase: (50ms/div).

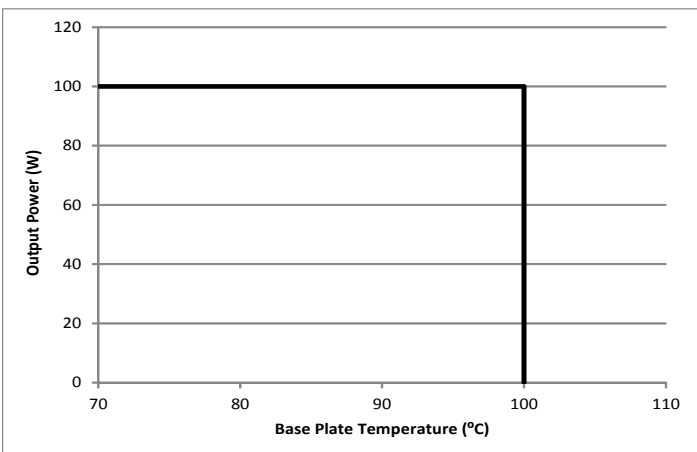

Figure 17: Maximum output power vs. base plate temperature derating curve.

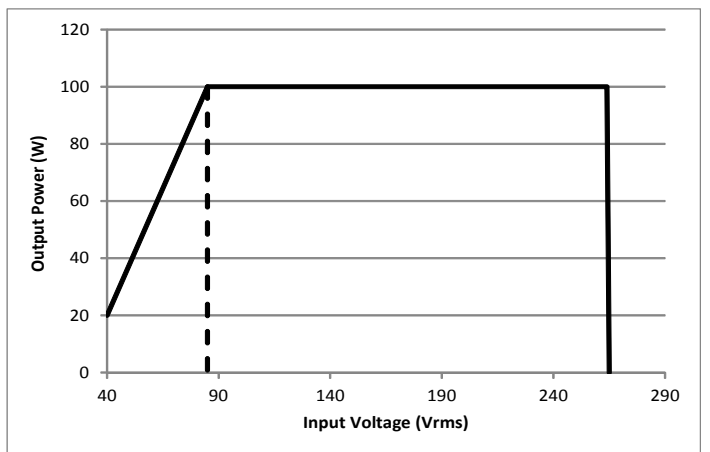

Figure 18: Maximum output power vs. input voltage, output turn-on threshold is 85Vrms.

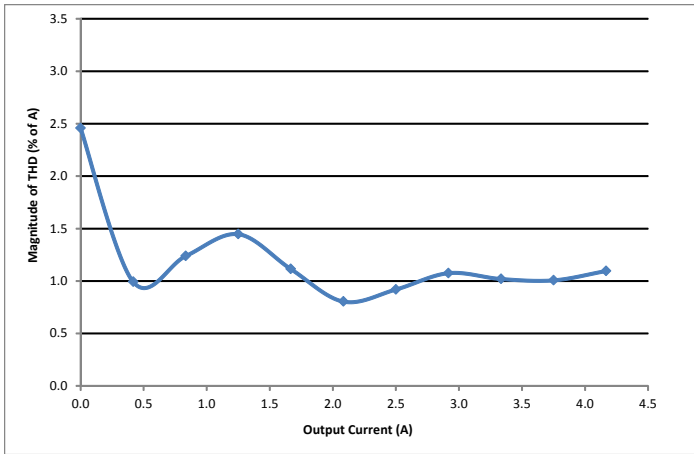

Figure 19: Total current harmonics at 60Hz, 115Vrms vs output current (Tested with APFIC module and ACF-U-230-QM).

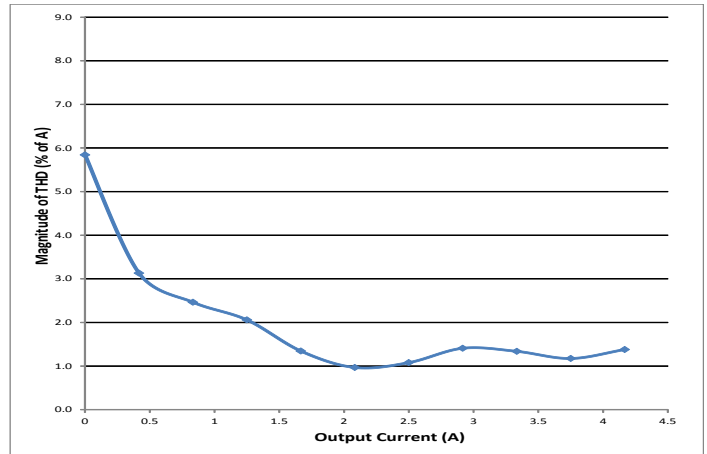

Figure 20: Total current harmonics at 400Hz, 115Vrms vs output current (Tested with APFIC module and ACF-U-230-QM).

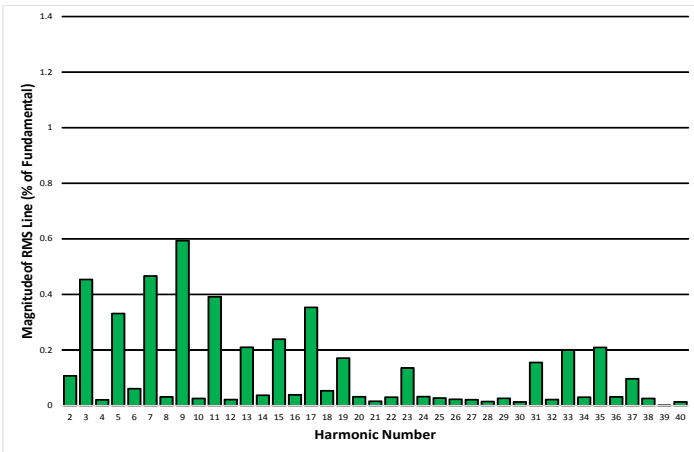

Figure 21: Input current harmonics at full load, 115Vrms 60 Hz (Tested with APFIC module and ACF-U-230-QM).

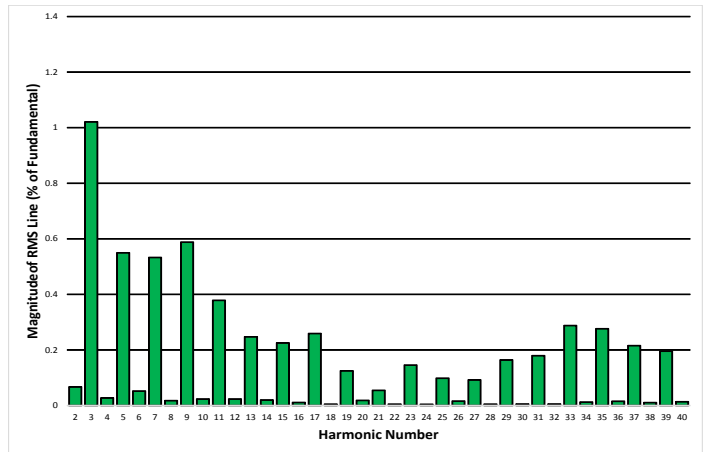

Figure 22: Input current harmonics at full Load, 115Vrms 400 Hz (Tested with APFIC module and ACF-U-230-QM).

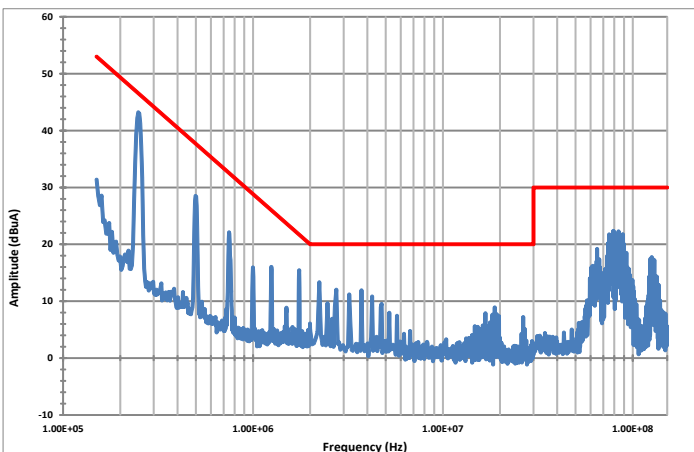

Figure 23: High frequency RTCA/DO-160G conducted emissions of ACF-U-230-QM filter and APFIC-U converter at full load, 115Vrms 60 Hz, category M limit. Preliminary.

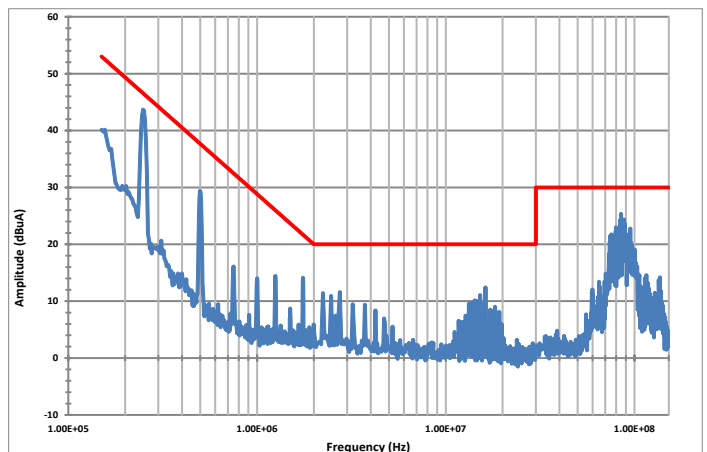

Figure 24: High frequency RTCA/DO-160G conducted emissions of ACF-U-230-QM filter and APFIC-U converter at full load, 115Vrms 400 Hz, category M limit. Preliminary.



APFIC-U-24x-HM-x
Input: 85-264 Vrms
Output: 24 Vdc
Power: 100 W

Standards & Qualification

Parameter	Notes & Conditions
-----------	--------------------

STANDARDS COMPLIANCE

CE Marked

Note: An external input fuse must always be used to meet these safety requirements. Contact SynQor for official safety certificates on new releases or download from the SynQor website.

Parameter	# Units	Test Conditions
-----------	---------	-----------------

QUALIFICATION TESTING

Cold Temperature - Ground Survival	5	RTCA/DO-160G Section 4.5.1
Hot Temperature - Ground Survival	5	RTCA/DO-160G Section 4.5.3
Cold Temperature - Operating	5	RTCA/DO-160G Section 4.5.2
Hot Temperature - Operating	5	RTCA/DO-160G Section 4.5.4
Temperature Variation	5	RTCA/DO-160G Section 5.3.1
Temperature Cycling	5	MIL-STD-810G Method 503.5 – Procedure I
Humidity	3	RTCA/DO-160G Section 6.3.1 (Category A)
Waterproofness - Condensing	3	RTCA/DO-160G Section 10.3.1 (Category Y)
Fungus Resistance	1	MIL-STD-810G Method 508.6
Vibration - Fixed Wing and Helicopter	5	RTCA/DO-160G Sections 8.5.2 (Level B4), 8.8.3 (Levels G and F1)
Operational Shock and Crash Safety	5	RTCA/DO-160G Section 7.2.1, 7.3.1, and 7.3.3 (Category B)
Altitude - Steady State	5	RTCA/DO-160G Section 4.6.1; 70,000 ft (21 km), see note
Altitude - Decompression	5	RTCA/DO-160G Section 4.6.2
Design Marginality	5	Tmin-10 °C to Tmax+10 °C, 5 °C steps, Vin = min to max, 0-105% load
Life Test	32	95% rated Vin and load, units at derating point, 1000 hours
Solderability	15 pins	MIL-STD-883, Method 2003

Note: A conductive cooling design is generally needed for high altitude applications because of naturally poor convection cooling at rare atmospheres.

Category Description	Single-Phase 115Vrms Specification Compliance
Input Voltage	787B3-0147, D6-44588, Airbus ABD0100.1.8, RTCA/DO-160G
Switching Transients	787B3-0147, D6-44588, Airbus ABD0100.1.8, RTCA/DO-160G, EN61000-4-4, EN61000-4-5
Voltage Spikes	787B3-0147, D6-44588, Airbus ABD0100.1.8, RTCA/DO-160G, EN61000-4-6
Frequency Transients	787B3-0147, D6-44588, Airbus ABD0100.1.8, RTCA/DO-160G
Harmonic Content	787B3-0147, D6-44588, Airbus ABD0100.1.8, RTCA/DO-160G, EN61000-3-2, MIL-STD-1399
DC Content on Input Voltage	787B3-0147, D6-44588, Airbus ABD0100.1.8, RTCA/DO-160G
Audio Frequency Conducted Susceptibility	D6-36440, RTCA/DO-160G
Audio Frequency Conducted Emissions	D6-36440, RTCA/DO-160G
Induced Signal Susceptibility	D6-36440, RTCA/DO-160G, EN61000-4-6
Conductive Emissions	D6-36440, RTCA/DO-160G, EN55011/22
Magnetic Effect	D6-36440, RTCA/DO-160G, EN61000-4-11
Radiated Emissions	D6-36440, RTCA/DO-160G, EN61000-4-3
Electrostatic Discharge	D6-36440, RTCA/DO-160G, EN61000-4-2
Electrical Bonding and Grounding	D6-36440, D6-44588, UL 60950-1
Lightning Requirements	D6-36440, D6-16050-5, RTCA/DO-160G
Reliability	Telcordia, MIL-HDBK-217F

Basic Operation & Features

The AeroQor isolated power factor correction module is a high efficiency, high power AC-DC converter. It operates from a universal AC input to generate an isolated DC output voltage. Both regulated and semi-regulated (droop version) modules are available. As shown in Fig. A, a typical power supply would be comprised of a SynQor AC Line Filter, a SynQor AeroQor module and an energy storage hold-up capacitor. A fuse is needed to meet safety requirements.

One of the primary purposes of the AeroQor is to shape the input current that is drawn from a single-phase sinusoidal AC source into a nearly perfect sinusoidal waveform so that the AC-DC power supply will present a very high power factor load to this source. In doing this wave-shaping, the AeroQor ensures that the harmonic components of the AC current waveform are below the levels called for in testing standards. The total harmonic distortion of the AC current waveform is typically less than 1.5% at full load.

The AeroQor accomplishes its wave-shaping task by first rectifying the filtered AC source voltage, and then processing the input power through a non-isolated, high-efficiency, high-frequency “boost converter” that both gives the input AC current its sinusoidal shape and provides a regulated DC voltage across the hold-up capacitor. This stage is then followed by a highly efficient, fixed duty cycle isolation stage, which provides the isolated output voltage. For regulated output modules, the output voltage is sensed and this information is sent to the primary side control circuitry through a digital isolator. The DC voltage across the hold-up capacitor is then adjusted to keep the output voltage regulated.

The hold-up capacitor handles the cyclic imbalance between the flow of energy drawn from the AC source and the flow of energy delivered to the load. This energy imbalance has a cyclic frequency twice that of the AC source voltage (e.g. 120Hz for a 60Hz input or 800Hz for a 400Hz input). This relatively low frequency makes the hold-up capacitor relatively large. Another purpose of the hold-up capacitor is to be a source of energy so that the output can continue to deliver load power during a temporary brownout or dropout of the AC source. A typical power supply will have sufficient hold-up capacitor to give a “hold-up time” in the 20ms range, but longer times can be achieved with yet more hold-up capacitance.

Besides shaping the AC current waveform, the AeroQor performs several other important functions. At start-up it controls the level of inrush current drawn from the AC source to charge the hold-up capacitor. It limits the DC current that can be drawn from the hold-up terminals and it will shut-down if a short circuit appears across the hold-up terminals. It will also shut-down if the AC input voltage is out of its range (either

too high or too low) for too long, or if the temperature of the module is too high.

Also, the AeroQor has several input control signals that include **PFC ENABLE**, **AC_GOOD**, and **DC_GOOD**. All of these signals are described in more detail below. There is also an auxiliary bias supply that can be used to power a low power control circuit. All control signals and **AUX** are referenced to **HU-**.

Start-Up Sequence

When the AC source voltage is first applied, regardless of whether the AeroQor is enabled or disabled through its **PFC ENABLE** pin, the AeroQor will pre-charge the output hold-up capacitor with a current limited to approximately 50mA. This pre-charging continues until the hold-up voltage is within approximately 10V of the peak voltage of the AC source. If, at this time, the **PFC ENABLE** input is logically high, and the AeroQor is therefore disabled, the AeroQor will remain in this pre-charged state indefinitely. The output voltage will remain at 0V.

When the **PFC ENABLE** input pin is pulled low, and after the pre-charging is completed if it is not already, the boost converter within the AeroQor will start operating and the AeroQor’s hold-up voltage will be increased to its nominal regulated value. After this regulated voltage level is achieved, the isolation stage within the AeroQor will then start operating. The converter’s output voltage will rise to its nominal value.

If the **PFC ENABLE** input is de-asserted (pulled high or allowed to float), the boost converter, as well as the isolation stage, in the AeroQor will shut down.

NOTE: The voltage across the hold-up capacitor will remain in a charged state after the AeroQor is disabled as long as the AC source voltage is present.

Brownout/Dropout Sequence

If the AC source voltage is present but it is below its continuous minimum input voltage limit, the AeroQor will still draw whatever power it can (within its current limit) from the AC source. This power may not be enough for the total load power, in which case the hold-up capacitor will provide the balance of the power. The voltage across the hold-up capacitor and output voltage will therefore drop as hold-up capacitor discharges.

If the AC source voltage drops below its specified transient minimum input voltage limit, the AeroQor’s boost converter will shut down and no longer deliver power to the output. Under this condition, all of the load power will be drawn from the hold-up capacitor.

If and when the voltage across the hold-up capacitor drops below its specified minimum limit, the isolation stage will stop operating and output will be turned off. This condition will cause the AeroQor to return to the beginning of the startup sequence described above.

NOTE: Regardless of what happens to the AeroQor's hold-up voltage under a brownout or dropout condition, if the AC source voltage drops below its rated under-voltage value for 1 second or more, the AeroQor will shut down.

If, however, the voltage across the hold-up capacitor does not drop below its specified minimum limit before the AC source voltage returns to within its continuous operating range (and it hasn't been absent for more than 1 second), the AeroQor will automatically re-establish its power flow. The hold-up capacitor will be recharged immediately to the peak of the AC source voltage (if it has fallen below this value) and to its nominal regulated voltage level within a few cycles of the AC source waveform.

NOTE: During the first phase where the hold-up capacitor is recharged (if this phase exists) there will be an inrush current drawn from the AC source that depends on the details of how quickly the AC source voltage returns to its normal operating condition.

Control Features

Auxiliary Power Supply (AUX):

The circuit shown below is an effective model for the AUX bias power supply:

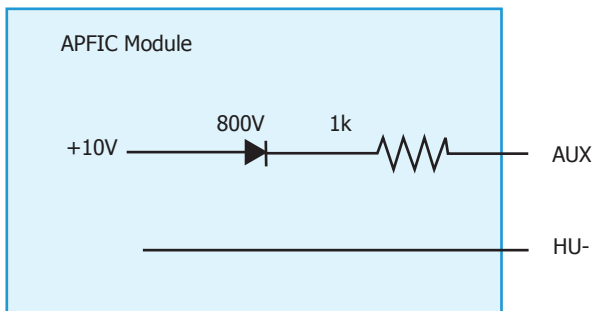

The purpose of the AUX power supply is to provide a low level of power to primary control circuitry, referenced to HU-.

The AUX power supply is present and regulated whenever the AeroQor's hold-up voltage is greater than approximately 75V. The AUX bias power supply is unspecified when AeroQor's hold-up voltage is less than about 75V (it may, for instance, come and go as the hold-up voltage rises on its way to 75V).

PFC_ENABLE:

The AeroQor uses the following circuit for this input logic signal:

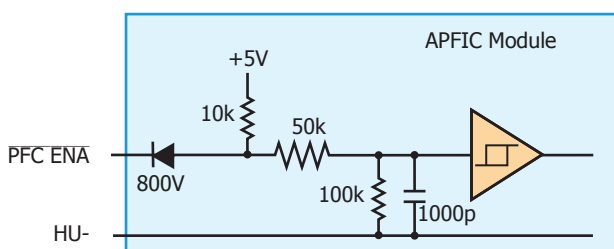

- If this input is floating or tied high the AeroQor's boost converter and its isolation stage are disabled.
- If this input is pulled low the AeroQor's boost is enabled after the pre-charger has charged the voltage across the hold-up capacitor to within approximately 10 volts of the peak of the AC source voltage. Isolation stage is turned on after hold-up voltage reaches regulation.

AC_GOOD:

The AeroQor uses this circuit for this output logic signal:

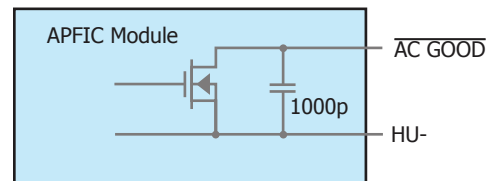

- The $\overline{AC_GOOD}$ signal is internally pulled low whenever the AC source voltage is within the AeroQor's continuous operating range for at least one cycle of the source waveform, regardless of whether the AeroQor is enabled or disabled.
- When the peak of the AC source voltage is outside this continuous operating range (either too high or too low), the $\overline{AC_GOOD}$ pin will float.
- The $\overline{AC_GOOD}$ signal is typically used with a pull-up resistor and an opto-coupler (as shown in Fig. A) to provide an isolated signal to the load that the AC source voltage is no longer within the specified continuous operating range. If this condition persists, the load power can only be delivered for the "hold-up time", and it may therefore be desirable to have the load gracefully shut down. The $\overline{AC_GOOD}$ signal provides a warning for this action to be taken. When the AC source voltage returns to the specified continuous operating range, the $\overline{AC_GOOD}$ signal will re-assert after a 100 ms delay.
- The $\overline{AC_GOOD}$ pin is valid whenever the AUX bias supply power is valid (see above).

DC_GOOD:

The AeroQor uses this circuit for this output logic signal:

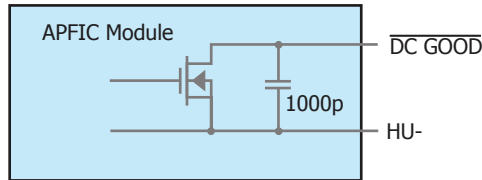

- The $\overline{\text{DC_GOOD}}$ signal is internally pulled low whenever the output voltage has reached regulation. The $\overline{\text{DC_GOOD}}$ signal is typically used with a pull-up resistor and an opto-coupler (as shown in Fig. A) to provide an isolated signal to the load.
- When multiple droop version units are used in parallel for higher power applications, the load should not exceed the rating of a single module until all of the individual $\overline{\text{DC_GOOD}}$ outputs have been asserted low.

Protection Features

Input Over- and Under-Voltage:

If the AC source voltage exceeds the maximum peak voltage rating defined in the electrical specifications, the AeroQor will shut down. However, under this condition the AeroQor's pre-charge circuit will continue to deliver 50mA of current to the hold-up capacitor whenever the AC source voltage is higher than the hold-up voltage. Care must be taken to insure this condition does not allow the hold-up voltage to rise high enough to damage the AeroQor.

If a brownout or dropout of the AC source voltage occurs, and if it lasts long enough for the AeroQor's hold-up voltage to drop below its specified minimum limit, the AeroQor will shut down. Furthermore, regardless of what happens to the AeroQor's hold-up voltage, if the AC source voltage drops below its rated under-voltage value for 1 second or more, the AeroQor will shut down.

After any shutdown, the AeroQor will automatically return to the beginning of the startup sequence described above.

Hold-up Over-Voltage:

If the hold-up voltage exceeds its specified maximum limit, the AeroQor will remain active, but will stop delivering power through its main boost stage until the hold-up voltage falls below the over-voltage threshold. Under this condition, the isolation stage will remain active and provide output voltage.

The AeroQor's pre-charge circuit will continue to deliver 50mA of current to the hold-up whenever the AC source voltage is higher than the hold-up voltage. Care must be taken

to ensure this condition does not allow the hold-up voltage to rise high enough to damage the AeroQor.

Output Current Limit and Short-Circuit Shutdown:

If the AeroQor's output is overloaded such that its output current limit becomes activated, the output voltage will fall as the excess load current discharges the hold-up capacitor. The AeroQor will continue to deliver power into this overload condition for 1s, after which the unit will shut down and automatically return to the beginning of the startup sequence described above. If at any point the hold-up capacitor voltage falls below the peak of the AC source voltage, the AeroQor will immediately shut down and return to the startup sequence. In above situations, both boost and isolation stage will turn off.

The AeroQor responds to a short-circuit event by turning the isolation stage off. The output voltage of the AeroQor will drop to zero. During the short circuit event, the boost converter will continue to run and the hold-up capacitor will remain charged. The module then enters a hiccup mode where it repeatedly turns on and off until the short-circuit condition is removed. This prevents excessive heating of the converter.

The off time during a short-circuit event is a function of input frequency. For 50/60Hz input, off time equals 25 line cycles. For example, at 60Hz, off time is:

$$T_{off(60Hz)} = \frac{25}{60} = 417ms$$

For 400Hz input, off time is 200 line cycles:

$$T_{off(400Hz)} = \frac{200}{400} = 500ms$$

Over Temperature:

If the internal temperature of the AeroQor reaches 130°C, the AeroQor will turn off its boost converter and isolation stage. When the internal temperature falls below 110°C, the AeroQor will return to the beginning of the startup sequence described above.

Energy Storage Hold-Up Capacitor

The hold-up capacitor performs two functions:

- It handles the cyclic imbalance between the flow of energy drawn from the AC source and the flow of energy delivered to the load. In doing so, the voltage across the hold-up capacitor has a ripple at a frequency twice that of the AC source voltage (e.g. 120Hz for a 60Hz input or 800Hz for a 400Hz input). The larger the hold-up capacitor, or the higher the frequency of the AC source, the smaller this ripple will be.

- It provides a source of energy so that the AeroQor can continue to deliver load power during a temporary brownout or dropout of the AC source. The larger the hold-up capacitor the longer it can provide this energy. Often it will be made large enough to allow the load to be gracefully shutdown after the AC source has been outside of its normal range for a set amount of time. A typical “hold-up time” would be in the 20 ms range for a 50/60 Hz system.

The total energy stored in a hold-up capacitor having capacitance C at any given voltage V is:

$$E = \frac{1}{2}CV^2$$

The amount of energy, ΔE , which can be drawn from this capacitor depends on the capacitor’s initial voltage, V_i , and its final voltage, V_f . This energy equals the amount of power, P, which the load draw through the isolation stage from the hold-up capacitor times the length of time, Δt , which it takes for the hold-up capacitor’s voltage to drop from V_i to V_f . This energy can be equated to the hold-up capacitance according to the following formula:

$$\Delta E = \frac{P}{\eta_{ISO}} \Delta t = \frac{1}{2}C(V_i^2 - V_f^2)$$

In this formula, P is the load power and $\eta_{ISO} = 96\%$ is the isolation stage efficiency. This formula can be rearranged to find the minimum required value for C to provide the hold-up time desired for a given power level.

$$C_{min} = 2 \frac{P}{\eta_{ISO}} \Delta t / (V_i^2 - V_f^2)$$

For example, if we assume $P = 100W$, $\Delta t = 20ms$, $V_i = 400V$, $V_f = 300V$, and $\eta_{ISO} = 96\%$, then we would want a hold-up capacitance of at least $59.52\mu F$.

NOTE: In the above example, the hold-up voltage drops by 25% at the end of brownout period. This also means the output voltage will drop by 25%. More hold-up capacitance is recommended if the secondary output voltage needs to be maintained at a higher level.

NOTE: The AeroQor is able to operate with a minimum of $50\mu F$ of hold-up capacitance, but SynQor recommends at least $330\mu F$ if the power system will be required to conform to lightning surge standards. This is because the AeroQor relies on the hold-up capacitor to absorb most of the energy from a lightning surge.

NOTE: Even though the AeroQor limits the inrush current drawn from the AC source during its startup sequence, it will not necessarily limit this current at the end of a temporary brownout or dropout of the AC source when the hold-up capacitor’s voltage has not dropped below its minimum hold-up voltage limit. In such a condition the AeroQor will not

re-initiate a startup sequence and it will therefore not limit the current flowing through it. If the peak of the AC source voltage is greater than the hold-up capacitor’s voltage at the end of the brownout/dropout period, there will be a large inrush current for one half-cycle as the hold-up capacitor’s voltage is charged up to the peak of the AC source voltage. The larger the hold-up capacitor, the larger this inrush current will be. To limit inrush current during this event, limit the charging current of additional hold-up capacitance with a resistor and diode as shown below.

If it is desired to have a hold-up time longer than can be achieved with the maximum specified hold-up capacitance, then the circuit shown below can be used.

In this circuit the total hold-up capacitance is $(C1 + C2)$, and it can be made as large as desired as long as C1 does not exceed the maximum capacitance specified in the Technical Specifications table. The resistor, R_c , in series with C2 is present to limit the current that will charge this capacitor after a temporary brownout/dropout event. Its resistance should be large enough to limit the charging current. The diode in parallel with the resistor permits the load converters to draw whatever energy they need from C2 without being hindered by the resistor.

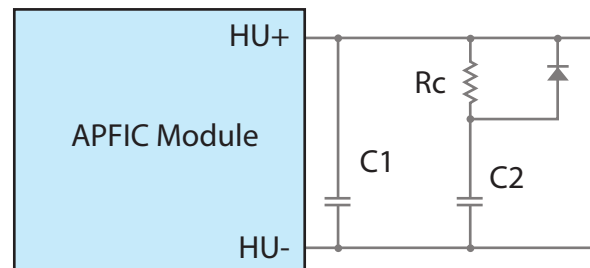

Output Ripple Considerations:

The hold-up capacitor must have a ripple current rating high enough to withstand the ripple current generated on the hold-up capacitor of the AeroQor. Ripple current amplitude is dependent only upon the total AeroQor output power, P_{DC} , isolation stage efficiency $\eta_{ISO} = 96\%$, and the operating hold-up voltage $V_{HU} = 400V$. It can be calculated using the following formula:

$$I_{Crms} = \frac{P_{DC}}{\sqrt{2} \cdot \eta_{ISO} \cdot V_{HU}} = \frac{P_{DC}}{543}$$

The AC line frequency, f_{ac} , bulk capacitance, C, operating hold-up voltage, and output power will determine the amplitude of the voltage ripple present on the output of the AeroQor. It can be calculated with:

$$V_{pk-pk} = \frac{P_{DC}}{2\pi \cdot \eta_{ISO} \cdot f_{ac} \cdot C \cdot V_{HU}}$$

$$\text{At } 400\text{Hz: } V_{pk-pk} = \frac{P_{DC}}{9.65 \cdot 10^5 \cdot C}$$

For example, to calculate the hold-up capacitor's voltage and current ripple for a AeroQor with a 100W output, 200µF hold-up capacitor, and a 400Hz fundamental AC line frequency:

$$I_{Crms} = \frac{100W}{543.06} = 0.184A_{rms}$$

$$V_{pk-pk} = \frac{P_{DC}}{2\pi \cdot 0.96 \cdot 400 \cdot 200 \cdot 10^{-6} F \cdot 400V} = 0.52V_{pk-pk}$$

In this case, the hold-up capacitor would require a minimum ripple current rating of 0.184A_{rms}, and the hold-up voltage would have a pk-pk ripple voltage of 0.52V, or 0.13%. Since the isolation stage is fixed duty cycle, the secondary output voltage will also have a 0.13% ripple at 2x the line frequency.

Safety Notes

The output of the AeroQor is isolated from the AC source. But the hold-up voltage and the control signals are primary-side referenced and are therefore hazardous voltages. Care must be taken to avoid contact with primary-side voltages, as well as with the AC source voltage.

The AeroQor must have a fuse in series with its AC source. The rating for this fuse is given in the Technical Specification.

Thermal Consideration

The maximum operating base-plate temperature, T_B, is 100°C. Refer to the thermal derating curves to see the allowable power output for a given baseplate temperature and input voltage. A power derating curve can be calculated for any heatsink that is attached to the base-plate of the converter. It is only necessary to determine the thermal resistance, R_{THBA}, of the chosen heatsink between the base-plate and the ambient air for a given airflow rate. The following formula can then be used to determine the maximum power the converter can dissipate for a given thermal condition:

$$P_{diss}^{max} = \frac{T_B - T_A}{R_{THBA}}$$

This value of power dissipation can then be used in conjunction with the data shown in the figures to determine the maximum load power that the converter can deliver in the given thermal condition.

AC Line Filter

An AC line filter is needed to attenuate the differential- and common-mode voltage and current ripples created by the AeroQor and the load, such that the system will comply with EMI requirements. The filter also provides protection for the AeroQor from high frequency transients in the AC source voltage. SynQor has a family of AC line filters that will provide these functions. It is recommended that a metal-oxide varistor (MOV) be placed from line-to-line on the input of the filter, and a TVS diode be placed from line-to-line on the output of the filter in order to keep the AeroQor input voltage from exceeding 450V during all transients, except when the PFC is disabled, when the input can tolerate 575V transients for up to 100ms. See Figure A for example parts. If a non-SynQor AC line filter is used, the use of an MOV on the input and a TVS diode on the output of the filter is still recommended.

EMI Considerations

To meet various conducted line emission standards, additional Y-capacitors may be needed to attenuate common-mode noise. SynQor recommends that safety-rated ceramic capacitors be placed from HU- to Vout- and Vout- to ground. However, the total capacitance from the APFIC HU- leads to earth ground should not be more than 20nF if one of the APFIC input leads is connected to earth ground. See "Typical Application of the APFIC Module" (Figure A) for a diagram and suggested parts.

Paralleling Multiple APFICQors

In higher power applications, multiple droop version units can be used in parallel.

- Only droop version units can be used in parallel. Current share is accomplished by passive droop sharing method.
- On startup, total load should not exceed the rating of a single module until all of the individual DC_GOOD outputs have been asserted low.

Operation at High Input Voltages

If the AC input voltage exceeds about 250 Vrms, both the hold-up voltage and output voltage will be raised up in order to maintain proper input current power factor correction. Output voltage can increase by up to 15% from the nominal output set point as input voltage increases from 250 Vrms to 264 Vrms.



APFIC-U-24x-HM-x
Input: 85-264 Vrms
Output: 24 Vdc
Power: 100 W

Encased Mechanical

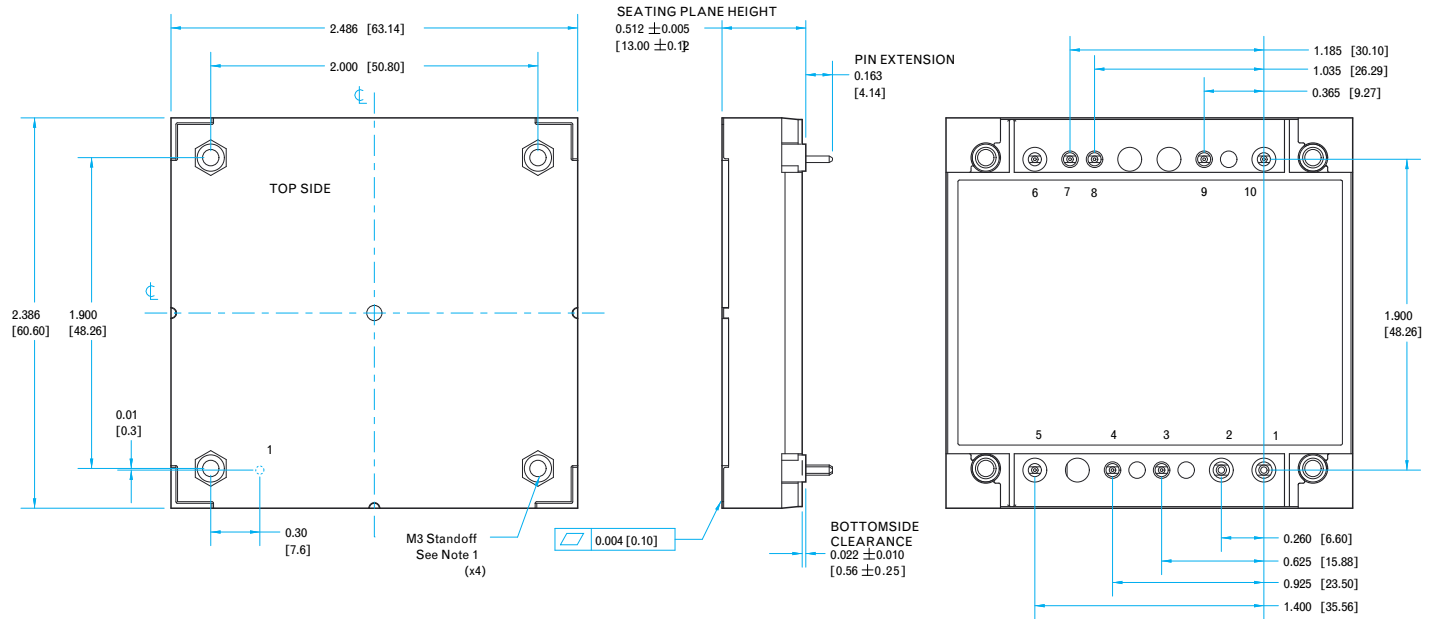

NOTES

- 1) Applied torque per M3 screw should not exceed 6in-lb. (0.7 Nm).
- 2) Baseplate flatness tolerance is 0.004" (.10 mm) TIR for surface.
- 3) Pins 1 and 2 are 0.062" (1.57mm) diameter with 0.100" (2.54mm) diameter standoff shoulder
- 4) Pins 3-10 are 0.040" (1.02mm) diameter, with 0.080" (2.03mm) diameter standoff shoulders.
- 5) All Pins: Material - Copper Alloy; Finish - Matte Tin over Nickel plate
- 6) Undimensioned components are shown for visual reference only.
- 7) Weight: 4.8 oz (136 g)
- 8) Threaded and Non-Threaded options available
- 9) All dimensions in inches (mm).

Tolerances:

- x.xx +/-0.02 in. (x.x +/-0.5mm)
- x.xxx +/-0.010 in. (x.xx +/-0.25mm)
- unless otherwise noted.

- 10) Workmanship: Meets or exceeds IPC-A-610C Class II

PIN DESIGNATIONS

Pin	Name	Function
1	VOUT+	Positive Output Voltage
2	VOUT-	Negative Output Voltage
3	L1	AC Line 1
4	PFC ENA	Negative Logic PFC Enable, Referenced to HU-
5	L2/N	AC Line 2 / Neutral
6	AC GOOD	Negative Logic AC Good Signal, Referenced to HU-
7	DC GOOD	Negative Logic DC Good Signal, Referenced to HU-
8	AUX	Auxiliary Bias Power Supply, Referenced to HU-
9	HU-	Negative Hold-up Voltage
10	HU+	Positive Hold-up Voltage

Encased Mechanical with Flange

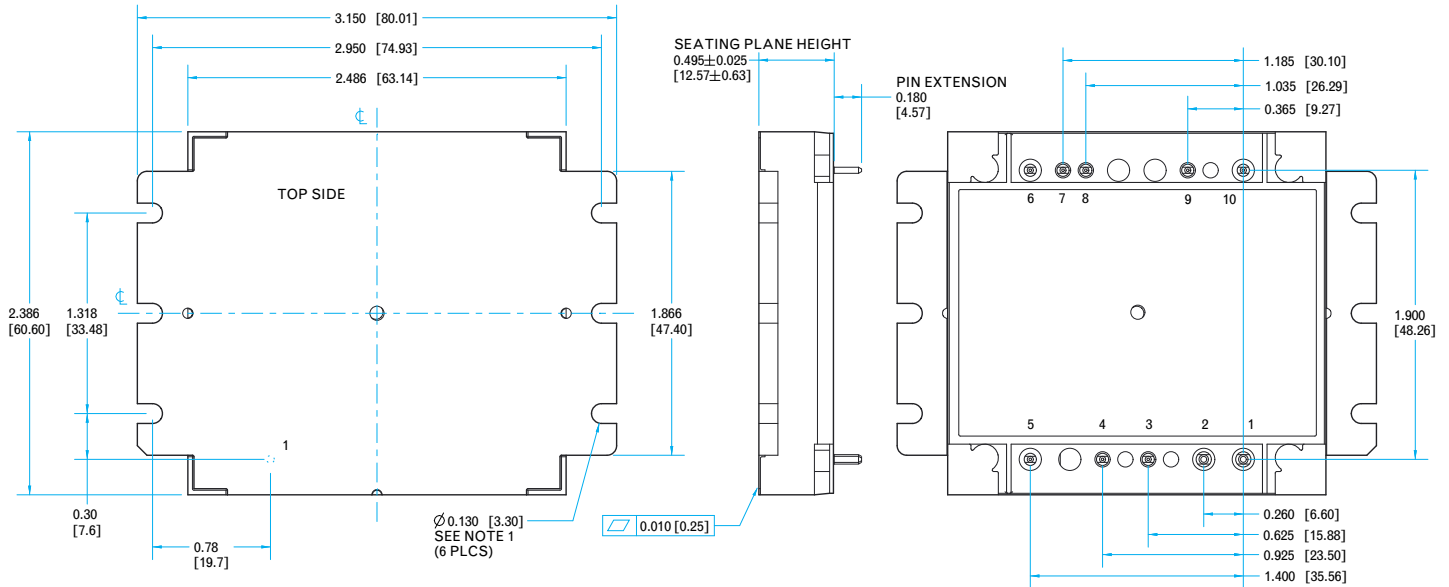

NOTES

- 1) Applied torque per M3 or 4-40 screw should not exceed 6in-lb. (0.7 Nm).
- 2) Baseplate flatness tolerance is 0.010" (.2mm) TIR for surface.
- 3) Pins 1 and 2 are 0.062" (1.57mm) diameter with 0.100" (2.54mm) diameter standoff shoulder
- 4) Pins 3-10 are 0.040" (1.02mm) diameter, with 0.080" (2.03mm) diameter standoff shoulders.
- 5) All Pins: Material - Copper Alloy; Finish - Matte Tin over Nickel plate
- 6) Undimensioned components are shown for visual reference only.
- 7) Weight: 5.0 oz (142 g)
- 8) All dimensions in inches (mm).
 Tolerances:
 x.xx +/-0.02 in. (x.x +/-0.5mm)
 x.xxx +/-0.010 in. (x.xx +/-0.25mm)
 unless otherwise noted.
- 9) Workmanship: Meets or exceeds IPC-A-610C Class II

PIN DESIGNATIONS

Pin	Name	Function
1	VOUT+	Positive Output Voltage
2	VOUT-	Negative Output Voltage
3	L1	AC Line 1
4	PFC ENA	Negative Logic PFC Enable, Referenced to HU-
5	L2/N	AC Line 2 / Neutral
6	AC GOOD	Negative Logic AC Good Signal, Referenced to HU-
7	DC GOOD	Negative Logic DC Good Signal, Referenced to HU-
8	AUX	Auxiliary Bias Power Supply, Referenced to HU-
9	HU-	Negative Hold-up Voltage
10	HU+	Positive Hold-up Voltage



APFIC-U-24x-HM-x
Input: 85-264 Vrms
Output: 24 Vdc
Power: 100 W

Ordering Information

Part Numbering Scheme						
Family	Input Voltage	Output	Regulation	Package Size	Thermal Design	RoHS
APFIC	U: 85-264 Vrms	24: 24V	R: Regulated Output D: Droop Sharing	HM: Half-brick Mega	C: Encased D: Encased with Non-threaded Baseplate V: Encased with Flanged Baseplate	G: RoHS

Example: APFIC-U-24D-HM-C-G
APFIC-U-24R-HM-D-G

RoHS Compliance: The EU led RoHS (Restriction of Hazardous Substances) Directive bans the use of Lead, Cadmium, Hexavalent Chromium, Mercury, Polybrominated Biphenyls (PBB), and Polybrominated Diphenyl Ether (PBDE) in Electrical and Electronic Equipment. This SynQor product is 6/6 RoHS compliant. For more information please refer to SynQor's RoHS addendum available at our [RoHS Compliance / Lead Free Initiative web page](#) or e-mail us at rohs@synqor.com.

Validation, Verification & Certification

USA Manufacturing Facility: AS9100 & ISO 9001 Certified

SynQor considers in-house manufacturing to be a core competency and strategic advantage. All SynQor products are manufactured in our manufacturing facility at our corporate headquarters in Boxborough, MA, USA, utilizing state-of-the-art equipment and proprietary assembly techniques. By maintaining both AS9100 and ISO9001 certifications, SynQor is able to provide the same level of attention to detail in our manufacturing processes as we do in our products. We utilize proprietary in-house developed manufacturing data and document control systems that allow us to operate in a paperless manufacturing environment, providing both maximized manufacturing efficiency and flexibility. Ultimately, our manufacturing expertise remains in-house, allowing us to maintain complete control over the quality and traceability of our product down to the component level to meet the most stringent customer and industry requirements.

Design, Engineering & Manufacturing Process

SynQor employs a stringent, ECO controlled, 5-stage product development process, starting with product concept design and ending with manufacturing integration. We believe that a solid design and DFM review process leads to efficient manufacturing, higher performance, and enhanced reliability. By designing for reliability, SynQor greatly reduces the chance of field defects and increases product integrity.

Concept Design	Design & Verification	Proof of Design	Proof of Manufacturing	Manufacturing Integration
<ul style="list-style-type: none"> • Generate electrical specification • Review performance requirements • Design simulation • Schematic • Qualify new components • Breadboard • Prelim thermal analysis 	<ul style="list-style-type: none"> • Full layout • DFM/DFT Review • Build engineering prototypes • Debug circuit • Worst-case electrical testing • Component stress analysis • Stability analysis • Abnormal electrical testing • Specification review • Preliminary datasheet 	<ul style="list-style-type: none"> • Build units and electrically characterize • Verify electrical performance • Verify component stress analysis • Statistical variations • Thermal analysis and imaging • HALT testing • Complete datasheet 	<ul style="list-style-type: none"> • Controlled Production Build • ATE testing • Yield analysis • Validate and finalize manufacturing processes and Tooling • 1000 hour life test • Qualification testing (humidity, vibration, DMT, PTC, thermal and mechanical shock, altitude and solderability) 	<ul style="list-style-type: none"> • Processes transfer • Full documentation release (SCD's, BOM, processes, procedures, etc.) • Release qualification reports • Release final datasheet • Transfer units to finished goods

Contact SynQor for further information and to order:

Phone: 978-849-0600 **Toll Free:** 888-567-9596 **Fax:** 978-849-0602

E-mail: power@synqor.com **Web:** www.synqor.com

Address: 155 Swanson Road, Boxborough, MA 01719 USA

WARRANTY

SynQor offers a two (2) year limited warranty. Complete warranty information is listed on our website or is available upon request from SynQor.

PATENTS

SynQor holds numerous U.S. patents, one or more of which apply to most of its power conversion products. Any that apply to the product(s) listed in this document are identified by markings on the product(s) or on internal components of the product(s) in accordance with U.S. patent laws. SynQor's patents include the following:

6,896,526 6,927,987 7,050,309 7,765,687

7,787,261 8,149,597 8,644,027